

# Effective placement of dangerous goods cars in rail yard marshaling operation

Morteza Bagheri, F. Frank Saccomanno, and Liping Fu

**Abstract:** Train derailments are important safety issues, and they become even more critical when dangerous goods (DG) are involved. This paper is concerned with mitigating derailment risk through improved operational strategies, with a specific focus on DG marshaling practices in the train-assembly process. A new modelling framework is proposed to investigate how the position of DG railway cars affects their chances of being involved in a derailment as the train travels over a given track segment. The underlying research problem can be formulated as a linear integer programming technique. However, since solving this formulation is computationally intractable, a heuristic method has been developed based on a genetic algorithm that gives a near-optimum solution. The proposed model is applied to a hypothetical rail corridor to demonstrate how effective marshaling of DG along a train can reduce overall derailment risks.

*Key words:* rail transportation, derailment, dangerous goods, risk, rail yard, marshalling.

**Résumé :** Les déraillements de train représentent une importante question de sécurité, plus particulièrement lorsque des matières dangereuses sont impliquées. Le présent article traite de l'atténuation du risque de déraillement par l'amélioration des stratégies opérationnelles, plus spécifiquement sur le positionnement des wagons de matières dangereuses durant le classement des wagons. Un nouveau cadre de modélisation est proposé pour examiner la manière dont la position des wagons de matières dangereuses affecte leur chance d'être impliqués dans un déraillement lorsque le train roule sur un segment de voie ferrée donné. Le problème sous-jacent peut être formulé comme une technique de programmation linéaire par nombres entiers. Toutefois, étant donné que la résolution de cette formulation est difficilement calculable, une méthode heuristique a été développée en se basant sur un algorithme génétique qui offre une solution près de l'optimal. Le modèle proposé est appliqué à un corridor hypothétique de voie ferrée afin de démontrer comment un classement efficace des matières dangereuses le long d'un train peut réduire les risques lors d'un déraillement.

*Mots-clés :* transport ferroviaire, déraillement, matières dangereuses, risque, cour de triage, classement des wagons.

## Dangerous goods derailment risks

Rail accidents can be classified into three main types: derailments, collisions (including head on, rear end, and side), and highway railway grade crossing accidents. As illustrated in Fig. 1, derailments account for well over 50% of all train accidents in Canada and the US. Train derailments also contribute to a significant share of all transportation accident related personal injuries and property damage every year (TSB 2004). According to the US Federal Railroad Administration (FRA) database for the period 1997–2006 (FRA Office of Safety Analysis 2007), train derailments in the US account for over 300 personal injuries nationwide annually, with average property damage in the order of US\$300 million per year just for equipment (track, signals, and other structures).

The potential threat of personal injury and property damage becomes even more significant when cars carrying dan-

gerous goods (DG), called hazardous materials, are involved. This threat depends not only on the severity of the derailment but also on the types of DG involved and their combined propensity for fires, explosions, and toxic impacts. According to FRA statistics for the period 1997–2006 (FRA Office of Safety Analysis 2007), derailments involving DG resulted on average in US\$500 000 per derailment of direct property damages in the US, a value that is considerably higher than that for similar derailments where DG are not involved (on average, US\$100 000 per derailment).

US railroads carry approximately 1.8 million carloads of DG annually, approximately 5% of the total rail freight movement (AAR 2006). In Canada, approximately 500 000 carloads of DG are shipped annually, or 12% of the total rail freight shipped nationwide (TSB 2004).

Between 1997 and 2006, the FRA Office of Safety Anal-

Received 1 May 2009. Revision accepted 3 February 2010. Published on the NRC Research Press Web site at [cjce.nrc.ca](http://cjce.nrc.ca) on 13 May 2010.

**M. Bagheri**,<sup>1,2</sup> Transportation Systems Research Group, Department of Civil and Environmental Engineering, University of Waterloo, 200 University Avenue West, Waterloo, ON N2L 3G1, Canada.

**F.F. Saccomanno and L. Fu**, Transportation Systems Research Group, Department of Civil and Environmental Engineering, University of Waterloo, 200 University Avenue West, Waterloo, ON N2L 3G1, Canada.

Written discussion of this article is welcomed and will be received by the Editor until 30 September 2010.

<sup>1</sup>Corresponding author (e-mail: [mbagheri@uwaterloo.ca](mailto:mbagheri@uwaterloo.ca)).

<sup>2</sup>Present address: School of Railway Engineering, Iran University of Science and Technology, Tehran 16846-13114, Iran.

**Fig. 1.** Rail accidents by type in the US (FRA Office of Safety Analysis 2007) and Canada (TSB 2007).

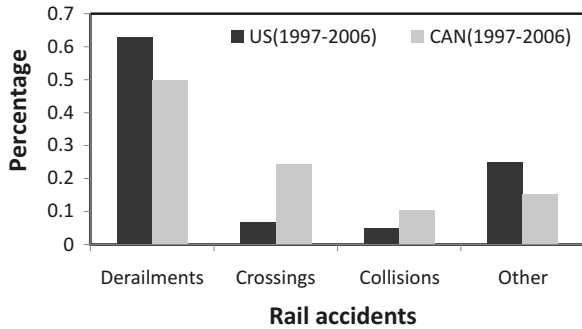

**Fig. 2.** Portion of US railway car derailments that involve DG for 1997–2006 (FRA Office of Safety Analysis 2007).

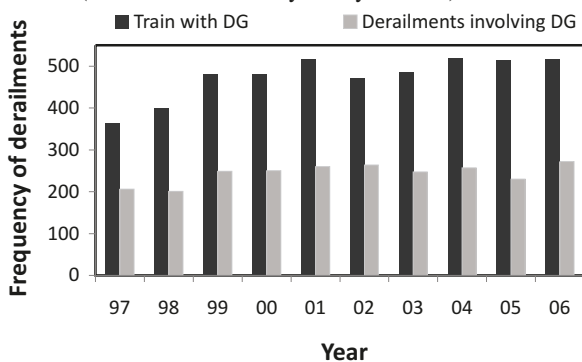

ysis (2007) reported that DG cars were involved in half of the total number of derailments of trains carrying DG in the US (Fig. 2).

Recently, Transport Canada announced a formal review of the *Railway Safety Act* to consider ways to manage and reduce the risks associated with the rail transport of DG (Transport Canada 2007a). In the US, the *Hazardous Materials Transportation Act* recommends an investigation into the placement of DG cars in general freight trains to reduce the potential of DG cars being involved in derailments. Section 111 of the *Hazardous Materials Transportation Authorization Act* of 1994 (P.L. 103–311) states the following: “The Secretary of Transportation shall conduct a study of existing practices regarding the placement of cars on trains, with particular attention to the placement of cars that carry hazardous materials. In conducting the study, the Secretary shall consider whether such placement practices increase the risk of derailment, hazardous materials spills, or tank ruptures or have any other adverse effect on safety.”

Recently, the Association of American Railroads (AAR 2006) underlined the preoccupation of railway companies with reducing the risk of DG transportation when it suggested that dealing with such risks could involve billions of dollars.

### Objectives of the study

The main aim of this paper is to introduce a DG train marshalling model that reduces DG involvements in derailments. Specifically, this research has three objectives: (i) to evaluate different risk-based approaches for marshalling of DG cars along a train consist, (ii) to develop a comprehen-

sive risk minimization model for effective marshalling of DG cars in a typical rail yard operation, and (iii) to apply the model to a hypothetical case study corridor with assumed DG shipment volumes and track derailment attributes.

The scope of the paper is limited to train assembly issues and is concerned with conventional freight train assembly only, which normally comprises a mix of different types of DG and general freight cars. Furthermore, although derailments can influence cars prior to the point of derailment, this paper is limited to derailed cars after the point of derailment (POD).

## Literature review

### Current regulations

The Canadian (*Transportation of Dangerous Goods Regulations, Part 10.6 “Location of Placarded Railway Vehicles in a Train”*; Transport Canada 2007b) and US (US DOT 49 CFR 174.85; USDOT 2007) regulations do not consider the relationship between car position and derailment probabilities.

Regulations for placement of DG cars serve two basic purposes, namely to keep DG separate from personnel and to keep incompatible DG materials separate from each other. For example, most regulations prevent locating any DG car next to an operating engine, occupied rail vehicle, or caboose to increase the safety of rail personnel. In addition, it is prohibited to assign a DG car next to a car with a source of ignition, or next to a flatcar with protruding lading, to reduce the likelihood of being released. Furthermore, it is not permitted to put incompatible DG cars next to each other.

Canadian Transportation of Dangerous Goods (TDG) (Transport Canada 2007b) classifies DG into nine classes, of which five are subject to special marshalling restrictions. Class 1 includes explosives; class 2, gases; class 3, flammable liquids; class 4, flammable solids; and class 5, oxidizing substances and organic peroxides. In addition, each DG has a unique number that must be displayed on a car placard.

Following the 1979 Mississauga, Ontario, train derailment, the Canadian Transport Commission (CTC) regulated the marshalling of DG cars. The main intent of the CTC regulations was to provide sufficient distance to separate train personnel from DG cars. Table 1 summarizes the current regulations concerned with the placement of DG cars along a train consist. Based on these regulations, it is prohibited for DG cars described in the first column to be placed next to cars described in the second column.

The US regulations on position of DG cars are similar to the Canadian regulations, as shown in Table 2. Nine DG classes are reclassified into four placard groups, and the cars that carry specific groups are not allowed to be located next to each other. For instance, placard group 1, which includes explosive materials, is not allowed to sit next to placard group 2, which includes compressed gas.

Furthermore, although the regulation of the International Carriage of Dangerous Goods by Rail (RID) is important in terms of providing overall guidelines, these do not address the problem of optimally positioning DG cars in terms of their potential for derailment (OTIF 2007). Although the regulation is important in terms of providing overall guide-

**Table 1.** Regulations for transport of dangerous goods in Canada (Transport Canada 2007b).

Dangerous goods	Railway vehicle
Any class of dangerous goods	An operating engine or an engine tender unless all the railway vehicles in the train, other than engines, tenders, and cabooses, have placards displayed on them; an occupied railway vehicle unless all the other railway vehicles in the train, other than engines, tenders, and cabooses, are occupied or have placards displayed on them; a railway vehicle that has a continual source of ignition; or a railway vehicle that is a flatcar from which part of the lading protrudes
Dangerous goods included in classes 1.1 or 1.2	Any railway vehicle that is required to have a placard displayed on it for classes 2, 3, 4, or 5
UN1008, boron trifluoride compressed; UN1026, cyanogen; UN1051, hydrogen cyanide, stabilized; UN1067, dinitrogen tetroxide or nitrogen dioxide; UN1076, phosgene; UN1589, cyanogen chloride, stabilized; UN1614, hydrogen cyanide, stabilized	Any railway vehicle that is required to have a placard displayed on it for classes 1, 2, 3, 4, or 5, unless the railway vehicle next to it contains the same dangerous goods
UN1660, nitric oxide, compressed; UN1911, diborane, compressed; UN1975, nitric oxide and dinitrogen tetroxide mixture or nitric oxide and nitrogen dioxide mixture; UN2188, arsine; UN2199, phosphine; UN2204, carbonyl sulphide or carbonyl sulfide; UN3294, hydrogen cyanide, solution in alcohol	Any railway vehicle that is required to have a placard displayed on it for classes 1, 2, 3, 4, or 5, unless the railway vehicle next to it contains the same dangerous goods

lines, these guidelines do not address the problem of optimally positioning DG cars in terms of their potential for derailment and operating costs.

### Current studies

Various studies have been conducted on train derailments over the last two decades. In 1979, the Volpe National Transportation Systems Center published a study (Fang and Reed 1979) suggesting that the front of a train is more prone to derail under loaded conditions, thus implying that DG cars should be placed closer to the rear. A similar study by Battelle (Thompson et al. 1989) divided the train into segments and then evaluated the probability of derailments for each segment. This study also provided a risk-based ranking of incompatible materials to determine the worst-case combinations of different types of DG being placed in proximity to one another. A study by the FRA (Nayak and Palmer 1980) concluded that empty cars should not be placed in the front, that is, the preferred position for loaded cars (DG and non-DG) should be the front part of the train. The Canadian Institute of Guided Ground Transport (CIGGT) (English et al. 1991) investigated the risk to train crews as related to position and separation distance of DG in conventional freight trains based on Canadian derailment data. This study offered no recommendations as to preferred low-risk placement of DG cars along the train.

Saccomanno and El-Hage (1991) established derailment profiles by position for shipments of DG. The main focus of this research was to determine the probability of derailment for each position along a given train and develop a model to predict the number of cars derailing by train derailment cause. The study did not explicitly consider train assembly operations in the rail yard. Another paper by Bagheri (2009) studied the risks associated with DG cars in railway stations. He investigated a catastrophic train derailment involving DG cars.

More recently, Anderson and Barkan (2004) studied derailment probabilities at an aggregate level using recent FRA data. A recent study by English et al. (2007) developed a derailment model at the disaggregate level based on the Canadian Railway Occurrence Data System (RODS). These studies failed to explicitly consider DG placement risks in rail yard marshalling operations.

The current research in North America does not provide adequate scientific evidence concerning the risk implications associated with DG car placement along the train consist. In the absence of such evidence, current practice in marshalling DG cars has been guided more by rail yard assembly costs and efficiencies than by the underlying risks involved (especially in transit).

### Estimating railway car derailments by position

The frequency of derailment by train position (based on historical derailment data from the US for the period 1992–2001) shows a strong relationship between position and derailment (Anderson and Barkan 2005).

A railway car can be involved in a derailment either by initiating a train derailment or by being part of the derailment block (all cars with the same destination) (Nicolet-Monnier and Gheorghe 1996). The estimation of derailment probability by position involves three basic steps: (i) estimating the probability of train derailment for different route attributes, (ii) analysing the causes of derailments, and (iii) estimating the initial point of derailment (POD) by cause and estimating the number of cars derailing. Each of these steps is discussed in more detail in the following sections.

### Probability of train derailment

Anderson and Barkan (2004) argued that the derailment probability of a freight train is a function of exposure (distance traveled), train length, and track class.

**Table 2.** Regulations for placarded cars in the US (USDOT 2007).

Restrictions	Placard group 1:		Placard group 2		Placard group 3		Placard group 4
	Rail car	Tank car	Rail car	Tank car	Rail car	Rail car	
When train permits, placarded car may not be nearer than the sixth car from the engine or occupied caboose	×	×		×			
When train length does not permit, placarded car must be placed near the middle of the train, but not nearer than the second car from an engine or occupied caboose	×	×		×			
A placarded car may not be placed next to an open-top car when any of the lading in the open-top car protrudes beyond the car ends or, if the lading shifted, would protrude beyond the car ends	×	×		×			
A placarded car may not be placed next to a loaded flatcar, except closed trailer on flatcar (TOFC) – container on flatcar (COFC) equipment, auto carriers, and other especially equipped cars with tie-down devices for securing vehicles; permanent bulkhead flatcars are considered the same as open-top cars	×	×		×			
A placarded car may not be placed next to any transport vehicle or freight container having an internal combustion engine or an open-flame device in operation	×	×		×			
Placarded cars may not be placed next to each other based on the following:							
Placard group 1		×	×	×	×	×	×
Placard group 2	×			×	×	×	×
Placard group 3	×	×	×	×			×
Placard group 4	×	×	×	×	×		

**Note:** Group 1 includes divisions 1.1 and 1.2 (explosive) materials. Group 2 includes divisions 1.3, 1.4, and 1.5 (explosives), with class 2 (compressed gas: other than division 2.3, PG I, zone A), class 3 (flammable liquid), class 4 (flammable solid), class 5 (oxidizing), class 6 (poisonous liquid; other than division 6.1, PG I, zone A), and class 8 (corrosive) materials. Group 3 includes division 2.3 (zone A: poisonous gas) and division 6.1 (PG I, zone A; poisonous liquid) materials. Group 4 includes class 7 (radioactive) materials.

**Table 3.** Federal Railroad Administration track classification based on speed of freight trains (FRA Office of Safety Analysis 2007).

	FRA track class					
	1	2	3	4	5	6
Max. speed (km/h)	16 (10)	40 (25)	64 (40)	97 (60)	129 (80)	177 (110)

**Fig. 3.** Comparison of point of derailment probability for different defects (FRA Office of safety Analysis 2007).

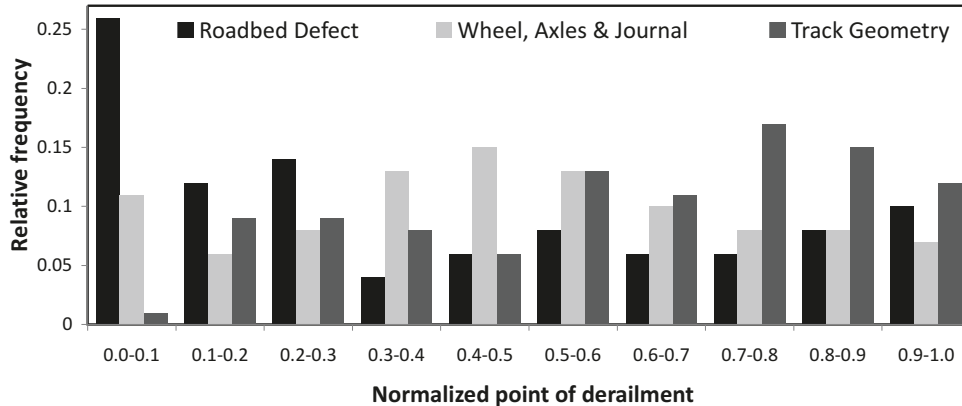

The FRA classifies track into six classes for freight trains based on various quality and speed considerations (Table 3).

The train derailment model developed by Anderson and Barkan (2004) is based on aggregate derailment data for different types of track classes in terms of the number of derailments per billion freight car miles (1 mile = 1.609 km) and the number of derailments per million freight train-miles, such that

$$[1] \quad P^{TD} = 1 - \exp \{-M[RC(L) + RT]\}$$

where  $P^{TD}$  is the probability of train derailment,  $M$  is the distance (miles),  $L$  is the train length (number of cars),  $RC$  is the derailment rate per billion freight car-miles, and  $RT$  is the derailment rate per million freight train-miles.

**Causes of train derailments**

Previous studies have shown that the point at which a train derailment begins is affected by the cause of derailment (El-Hage 1988). In addition, the numbers of cars involved in derailments have been found to depend on the cause of derailment and the operating speed (Thompson et al. 1989). Hence, to better understand the relationship between the POD and number of cars derailing, the distribution of causes in derailment data needs to be established.

The FRA database considers five primary causes of train derailments: (i) track, roadbed, and structure faults; (ii) signal and communication failures; (iii) mechanical and electrical failures; (iv) train operation – human factors; and (v) miscellaneous causes. Each primary cause class can be classified further according to the specific nature of the accidents. For example, track–roadbed–structure can be classified further into track geometry, rail, and switches.

The Canadian Railway Occurrence Data System (RODS) shows that 15.2% of mainline freight train derailments are caused by switches, and human errors cause 26.9% of freight train derailments (TSB 2007).

According to Arthur D. Little, Inc. (1996), train accidents

can be classified as either car-mile- or train-mile-related causes. Train-mile-related causes are independent of train length but depend essentially on the number of train movements traversing a given track segment. For instance, “human error” is a train-mile-related cause. On the other hand, “track component failures” and “equipment failures” are car-mile-related causes.

**Point of derailment (POD) and number of cars derailing**

It has previously been shown that a link exists between the cause of derailment and car position along the train. For instance, for derailments caused by “roadbed defects,” the US FRA derailment data suggest that the front of the train (front 10%) contributes to over 25% of all train derailments reported over the period 1997–2006 (FRA Office of Safety Analysis 2007). Figure 3 illustrates the distribution of the point of derailment (normalized by the length of train) as obtained from the FRA database for three major derailment causes: roadbed defects, wheel axle and journal defects, and track geometry. From this figure, “wheel, axles, & journal” defects reflect a higher frequency of POD for the middle of the train, whereas POD for “track geometry” causes are more likely to occur at the rear end of the train.

Saccomanno and El-Hage (1989) have shown that the number of cars derailing behind the POD is affected by three factors, namely train length, speed (mph, where 1 mph = 1.609 km/h), and primary cause of derailment. They introduced a truncated geometric distribution for the probability of  $x$  cars derailing, such that

$$[2] \quad P(x) = p(1 - p)^{(x-1)} / [1 - (1 - p)^{L_r}]$$

where  $x = 1, \dots, L_r$ , in which  $L_r$  is the residual length (number of cars after the POD); and  $p = \exp(Z) / [1 + \exp(Z)]$ , where  $1 - p$  is the probability of derailment for the car following the POD, and  $Z = \beta_0 + (\beta_1 \times \text{speed}) + (\beta_2 L_r) + (\text{parameters } \beta_3, \beta_4, \dots, \beta_8 \text{ for different causes})$ .

Based on CTC derailment data for 1983–1985, eq. [2]



was calibrated to give the following results:  $Z = 1.67 - (0.5755 \times \text{speed}) - (0.6381L_r) + 0.6479 \text{ roadbed defect} + 0.3842 \text{ track geometry} + 0.4702 \text{ switch defect} + 1.5105 \text{ general rail car defect} + 1.6722 \text{ axles and wheels defects} + 1.3292$  for all other causes. Train causes in eq. [2] were entered as dummy variables (0, 1), and speed (mph) and train length were given scalar values. For a given cause, eq. [2] suggests that the number of cars derailing increases with an increase in speed and an increase in train length.

**Marshalling of dangerous goods (MDG)**

The probability of DG involvement in a derailment can be decreased by systematically placing these cars in positions that are less prone to derail along a given route. Prior knowledge concerning the likelihood of derailment by cause and position along a route could assist in reducing derailments involving more sensitive positions along a train. A risk-based marshalling strategy would seek to exclude DG cars from these positions.

Conventional practice in train assembly is generally based on the first-come, first-serve principle, which tends to minimize rail yard operating time and costs. However, this practice does not consider the potential effect of DG car position on overall in-transit risk.

The minimum risk position for DG cars along a train can be obtained using two combinatorial train assembly approaches as follows:

One level (MDG\_1) — MDG\_1 considers  $n$  car placement positions. The problem is to allocate cars with or without DG to these positions. An optimization model needs to be developed that minimizes the risk of DG car derailments. A major constraint is the preservation of block integrity, that is, all cars with the same destination should be marshalled together in the same block.

Two levels (MDG\_2) — MDG\_2 consists of two sequential steps. First, the best combination of cars within each block needs to be determined; second, the order of the blocks along a given train must be established.

MDG\_1 considers a train consisting of  $n$  slots that could be assigned to individual cars of either DG or non-DG material. A given number of DG cars is to be allocated, and the objective is to minimize the total risk for all cars in terms of the probability of derailment and its consequence. All the restrictions can be defined as constraints of the optimization model, such as coupling of cars with the same destination (i.e., blocking).

To illustrate the major features of the model, consider a train with a single block consisting of 10 cars, three of which contain DG. The total number of possible combinations for placing these cars is equal to the total number of possible permutations, i.e.,  $890 (= P_3^{10})$ . To preserve block integrity, a constraint needs to be considered — strings of adjacent cars along the train share a common block — and this problem becomes very complicated.

MDG\_2 divides the marshalling problem into two decision problems. The first is to find the order of cars within each block (i.e., those with the same destination). The second is to find the order of blocks in the train consist. The optimal order of cars in a block depends on the probability of derailment, and this probability in turn depends on the or-

Fig. 4. Train consist for the proposed model.

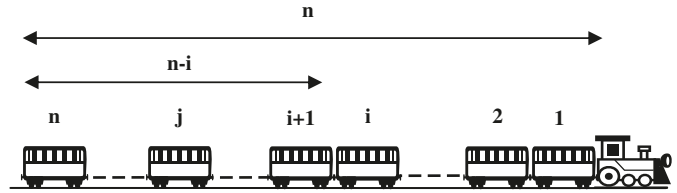

der of blocks. The best order of the cars within a given block cannot be determined until the order of the blocks is assumed. As a result, these two problems are interrelated and must be solved together iteratively.

In this paper, the MDG\_2 approach is considered to be more computationally tractable for marshalling DG cars and thus provides the basis for the subsequent discussion in this paper.

**Objective risk-based function and constraints**

This section provides a formulation of a simple variant of the problem and discusses the possible solutions to the problem. Within the context of the formulation, we define risk in terms of the expected number of DG cars derailing.

Consider a train with one destination and  $n$  cars (Fig. 4), of which  $m$  cars carry DG of the same type ( $m < n$ ).

The objective function is to minimize the total risk,  $\sum_{j=1}^n R_i$ , where  $R_i$  is defined as the product of the probability of derailment for position  $i$  ( $P_i$ ) and its consequence ( $C_i$ ), that is

$$[3] \quad R_i = P_i C_i$$

The probability of derailment for position  $i$  is the combination of two probabilities: (i) the probability of train derailment on a given route ( $P^{TD}$ ); and (ii) the conditional probability of beginning a derailment at position  $i$  (POD), given that the train derailed ( $P_i^{POD}$ ). The expression is of the form

$$[4] \quad P_i = P^{TD} P_i^{POD}$$

The consequence of derailment for position  $i$  (i.e.,  $C_i$ ) can be expressed as the product of the conditional probability of derailing  $x$  cars while the derailment happened at position  $i$  ( $P(X = x | I = i)$ ) and the cost of derailing  $x$  cars ( $C_x^i$ ):

$$[5] \quad C_i = \sum_{x=1}^{n-i+1} P(X = x | I = i) C_x^i$$

where  $X$  is the number of cars derailing, and  $I$  is the railway car position. In eq. [5],  $C_x^i$  can be expressed as

$$[6] \quad C_x^i = \sum_{j=i}^{i+x-1} \{(y_j C') + [(1 - y_j) C'']\}$$

where  $C'$  is the average cost of derailing a DG railway car;  $C''$  is the average cost of derailing a non-DG railway car; and  $y_j$  is the decision variable is binary, i.e.,  $y_j = 0$  or  $1$ , where  $y_j = 1$  refers to DG at position  $j$ , and  $y_j = 0$  refers to non-DG.

According to the FRA database for the period 1997–2006 (FRA Office of Safety Analysis 2007), the average cost of derauling a car ( $C'$ ) is approximately US\$100 000 if DG are involved and about US\$20 000 if a non-DG car ( $C''$ ) is involved.

$$[7] \quad R_i = \sum_{i=1}^n P_i^{TD} P_i^{POD} \left[ \sum_{x=1}^{n-i+1} P(X=x|I=i) \left( \sum_{j=i}^{i+x-1} \{(y_j C') + [(1-y_j) C'']\} \right) \right]$$

This objective function is subject to two constraints: (i) the total number of DG cars must be equal to the total number of DG cars required in a given block ( $\sum_{j=1}^n = m$ ); and (ii) the last restriction ensures there is at least one DG car in the train consist, and the total number of DG cars is less than the total number of cars ( $0 < m < n$ ).

In this simplified case, the restrictions of the model are very straightforward. However, more complicated constraints need to be considered when more realistic scenarios are investigated. The model is now applied to an MDG\_2 marshalling approach for DG car placement.

**Near-optimum DG placement using a genetic algorithm**

This problem can be solved using an integer programming (IP) method, which can be difficult to apply for a large number of positions, DG placement requirements, DG types, and destination blocks. For instance, consider a train with 100 cars, half of them carrying DG materials. Assuming that the train has only one destination and all the DGs have the same level of risk, the number of possible combinations is more than  $10^{29}$ .

In this paper, a genetic algorithm (GA) approach is adopted to find a near-optimum solution to this marshalling problem. Using conventional GA vernacular for chromosomes and genes, a block of cars can be defined as a chromosome, and each car can be defined as a gene (Fig. 5). The best chromosomes produce offspring chromosomes. Each time, an offspring chromosome is evaluated and will replace a weaker member if doing so provides a better result. This process continues for a number of generations to obtain a near-optimum solution (Elbeltagi et al. 2005). Each chromosome is evaluated using a risk-based objective function.

This paper uses Palisade Corporation Evolver software (www.palisade.com), a powerful genetic algorithm to solve the formulated optimization problems.

**Case study corridor application**

**Corridor specification**

The proposed model is applied to a hypothetical railway corridor to illustrate its major features and the effects of marshalling operations on overall derailment risk. Consider a railway corridor consisting of a rail yard and three stations, as shown in Fig. 6. Trains originate at a rail yard and are destined for stations A, B, and C. At each destination station, a block of cars is set off from the train. Therefore, each train consists of three blocks, labelled A, B, and C, with block A set off at station A, block B at station B, and block C at the final destination station C. It is assumed that

By combining eqs. [3], [4], [5], and [6], we obtain the  $R_i$  risk objective function for position  $i$ :

**Fig. 5.** Train consist as a string.

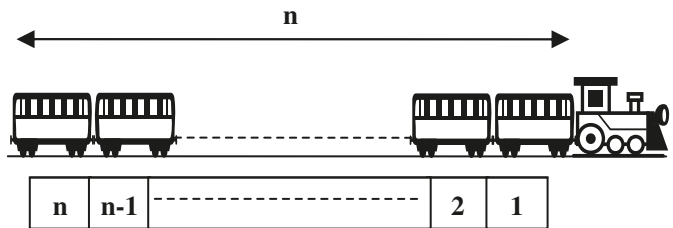

**Fig. 6.** Hypothetical rail corridor with three destinations (stations A, B, and C).  $R_1$ ,  $R_2$ , and  $R_3$  are the risks of derailment in the three segments.

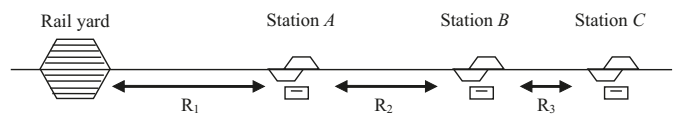

blocks A, B, and C include a total of 20, 30, and 50 cars, respectively, of which 5, 10, and 20 cars contain similar DG. The rail track from the departure point to station A is 1000 miles long and is classified as class two track (speed limit 25 mph). The distance between rail station A and rail station B is 500 miles on class three track (speed limit 40 mph). The last segment extends for 100 miles and is classified as class four track (speed limit 60 mph). Since we have assumed that the materials of each DG car are similar, according to the transportation of DG by rail regulation, these DG cars can be located next to one another. It is assumed that the main causes of derailments for segments 1, 2, and 3 are “roadbed defects,” “wheel, axles & journal”, and “track geometry”, respectively.

**Estimation of corridor risks (MDG\_2)**

As mentioned previously, the objective of the marshalling operations is to minimize the total risk ( $R$ ), such that

$$[8] \quad R = R_1 + R_2 + R_3$$

where  $R_1$ ,  $R_2$ , and  $R_3$  are the total risks in three segments.

Block A only traverses segment one ( $s = 1$ ), and block B traverses the first two segments ( $s = 1$  and 2). Block C traverses all three segments ( $s = 1, 2$ , and 3) of the hypothetical corridor. This can be expressed as

$$[9] \quad \begin{aligned} R_1 &= R_{1A} + R_{1B} + R_{1C} \\ R_2 &= R_{2B} + R_{2C} \\ R_3 &= R_{3C} \end{aligned}$$

Fig. 7. Possible combinations of railway cars in each block (1 refers to DG, and 0 to non-DG).

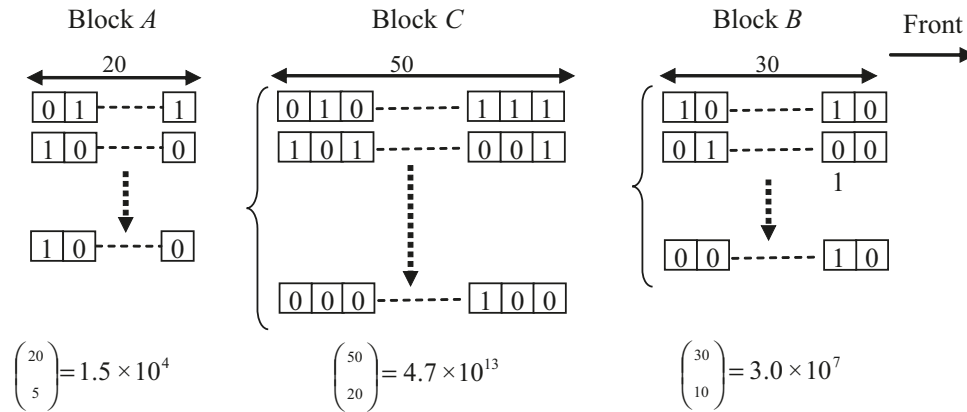

Thus, the eqs. [8] and [9] can be expressed as

$$[10] \quad R = \sum_{s=1}^3 \sum_{b=1}^3 R_{sb}$$

where  $R_{sb}$  is the total risk of derailment of block  $b$  in segment  $s$ .

Total risk of block  $b$  in segment  $s$  is a summation of each car risk in the block. For instance, for 30 cars in block B ( $b = 2$ ), the total risk over segment 1 is expressed as

$$[11] \quad R_{12} = \sum_{i=1}^{30} R_{12}^i = R_{12}^1 + R_{12}^2 + \dots + R_{12}^{30}$$

where  $R_{sb}^i$  is the risk for the car at position  $i$ . As mentioned in the previous section, the risk associated with the car at position  $i$  can be calculated from eq. [7].

Based on MDG\_2, we need to assume the order of blocks when calculating the probability of derailment for each position. To illustrate the problem, consider a train with three destinations: block B is located in the first position (the front of the train), block C in the second position, and block A in the third position (ACB). The terms A, B, and C correspond to three different destinations. Under the assumption that there is no difference between DG in terms of the level of hazard, the possible combinations are shown in Fig. 7 (1 refers to DG, and 0 to non-DG).

The probability of derailment for each position can be calculated. After assuming the order of blocks, the best combination of cars within each block can be identified by minimizing the total risk. This step repeats for the next assumed order of blocks. Note that changing the sequence of the blocks will change the best corresponding combination of cars in each block. At this level, each block has a corresponding risk value calculated in the first level. Thus, the risk of a whole train consist is the summation of the risks of all blocks. For all possible combinations of blocks (Fig. 8), this procedure repeats.

**Discussion of results**

From eq. [1], the probability of train derailment for each segment  $P_s^{TD}$  is calculated separately as follows:  $P_1^{TD} = 0.0812$ ,  $P_2^{TD} = 0.0119$ , and  $P_3^{TD} = 0.0004$ . These values are based on reported values for estimated derailment

Fig. 8. Possible combinations of the blocks.

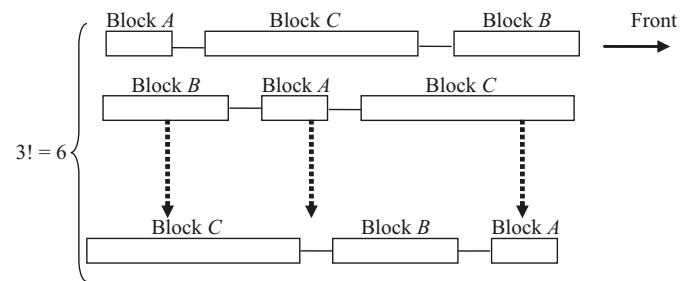

Table 4. Segment attributes and corresponding train derailment probability.

	Segment 1	Segment 2	Segment 3
Distance (miles)	1000	500	100
Train length (No. of cars)	100	80	50
Track class	2	3	4
RC ( $\times 10^{-9}$ )	69.50	23.60	5.85
RT ( $\times 10^{-6}$ )	1.520	0.510	0.132
$P_s^{TD}$	0.00812	0.00119	0.00004

**Note:** RC and RT are the corresponding derailment rates per billion freight car-miles and million freight train-miles, respectively.

rates (Anderson and Barkan 2004) and the route segment attributes summarized in Table 4. In this table, RC and RT are the corresponding derailment rates per billion freight car-miles and million freight train-miles, respectively.

The conditional probability of derailling at position  $i$  (POD) given that the train derailled,  $P_i^{POD}$ , is estimated from Fig. 3. The probability of the number of cars derailling on different segments of the case study corridor is obtained from eq. [2].

Applying the Evolver software (GA algorithm) to the case study corridor, the minimum risk values were obtained for each of the six different block combinations (Fig. 9).

Incurrent rail yard operations, the order of blocks is based on the order of rail stations (CBA). In this case, the marshalling order of blocks (CBA) could serve as the base case



**Fig. 9.** Comparison of different combinations of blocks (A, B, and C) with the best order of cars.

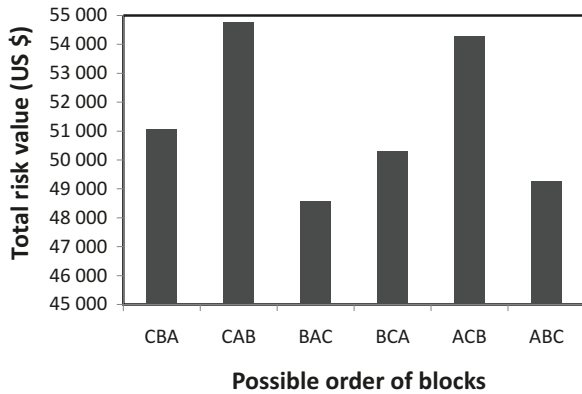

**Fig. 10.** Comparison of six different marshalling strategies.

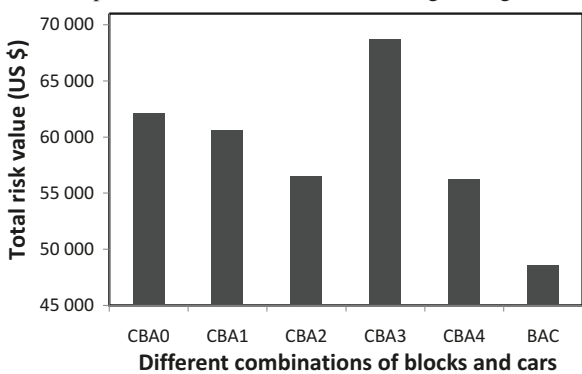

strategy for DG placement cars, which results in a 6% increase in risk over the best-case minimum risk configuration (BAC). The worst-case risks were obtained for CAB.

A number of different DG combination strategies are possible, including minimum risk (BAC). In addition to the first-come, first-serve (random) option (CBA0), four other possible CBA block combinations include (i) marshalling DG cars in each block based on the main derailment cause of each segment, moving DG cars in the first block to the back of the block, and putting DG cars in the second block to the front of the block and locating DG cars of block three to the middle of the block (CBA1); (ii) allocating DG cars to the rear end of each block (CBA2); (iii) putting DG cars at the front of each block (CBA3); and (iv) assigning DG cars to the middle of each block (CBA4).

Fig. 10 compares the best-case (BAC) marshalling strategy with the five different base-case options. As noted previously, marshalling DG cars and blocks based on the minimum risk BAC strategy produces safety benefits that are significantly greater than those for the other strategies considered in this exercise. According to current rail yard operations, in this case, CBA0, the corresponding risk is 28% higher than that for the best order of rail stations, BAC. It should be noted, however, that this comparison has considered only in-transit risk and excluded rail yard marshalling cost. To select a marshalling strategy that results in minimum overall risk, rail yard train assembly procedures and costs must also be considered.

## Conclusions

This paper has introduced a risk-based model for considering placement of dangerous goods (DG) railway cars along a train. The model makes use of derailment probabilities for different railway car positions along the train. These probabilities are affected by the speed and length of the train and the causes of derailment for given track segments. Causes of derailment are assumed to depend on track and train operating characteristics. This paper has presented a procedure for obtaining the probability of derailment by position for a given derailment cause. The model estimates the overall risks of different DG railway car marshalling strategies subject to destination block constraints.

The research problem has been stated as a combinatorial problem. Conventional linear integer programming techniques have been used to solve these types of problems; in this exercise, however, a heuristic genetic algorithm was selected to obtain near-optimum results, as the final structure of the problem is very complicated.

An application of the proposed model to a hypothetical rail corridor has been presented. The results indicate that current first-come, first-serve marshalling strategies potentially produce risks that may be significantly higher than the minimum risk DG placement strategy for the particular corridor under consideration.

Lastly, it should be noted that a number of assumptions have been introduced in our proposed optimization models. For example, all DG cars are assumed to impose the same level of hazard, whereas, in reality, different DG could result in significantly different damages. Moreover, according to regulations, incompatible DG cars should be separated by buffers. The underlying issue is not addressed in this paper. Furthermore, operating costs associated with marshalling and switching must be considered in placement optimization if truly optimal solutions are to be identified. Future research should therefore investigate the implications of these assumptions and develop improved models to address more realistic operating conditions.

## Acknowledgments

The comments and suggestions provided by Professors Shojaeddin Chenouri and Tarek Hegazi of the University of Waterloo are gratefully acknowledged. This study was funded by the School of Railway Engineering at IUST and by Transport Canada.

## References

- AAR. 2006. Current Rail hazmat conditions called “untenable.” Press release 13 June 2006, The Association of American Railroads (AAR), Washington, D.C. Available from [www.aar.org/ViewContent.asp?Content\\_ID = 3763](http://www.aar.org/ViewContent.asp?Content_ID = 3763) [cited 31 October 2007].
- Anderson, R.T., and Barkan, C.P.L. 2004. Railroad accident rates for use in transportation risk analysis. *Transportation Research Record* 1863(1), pp. 88–98. doi:10.3141/1863-12.
- Anderson, R.T., and Barkan, C.P.L. 2005. Derailment probability analysis and modeling of mainline freight trains. *In Proceedings of the 8th International Heavy Haul Conference, Rio de Janeiro, Brazil, 14–16 June 2005. Edited by C. Jorge. International Heavy Haul Association, Inc., Virginia Beach, Va.* pp. 491–497.
- Arthur D. Little, Inc. 1996. Risk assessment for the transportation

- of hazardous materials by rail. Supplementary report: railroad accident rate and risk reduction option effectiveness analysis and data. 2nd revision. Arthur D. Little, Inc., Boston, Mass.
- Bagheri, M. 2009. Risk analysis of stationary dangerous goods railway cars: a case study. *Journal of Transportation Security*, **2**(3), pp. 77–89.
- Elbeltagi, E., Hegazy, T., and Grierson, D. 2005. Comparison among five evolutionary-based optimization algorithms. *Advanced Engineering Informatics*, **19**(1): 43–53. doi:10.1016/j.aei.2005.01.004.
- El-Hage, S. 1988. Evaluating train marshalling regulations for railway cars carrying dangerous commodities. M.Sci. thesis, Department of Civil and Environmental Engineering, University of Waterloo, Waterloo, Ont.
- English, G.W., Cattani, T.K., and Schweir, C. 1991. Assessment of dangerous goods regulations in railway train marshalling. Canadian Institute of Guided Ground Transport, Queen's University, Kingston, Ont.
- English, G.W., Higham, G., Bagheri, M., Moynihan, T.W., and Saccomanno, F.F. 2007. Evaluation of risk associated with stationary dangerous goods railway cars. Transport Canada Publication TP 14690E, Transportation Development Centre, Montréal, Que.
- Fang, P., and Reed, H.D. 1979. Strategic positioning of railroad cars to reduce their risk of derailment. US DOT Volpe Transportation Systems Center (DOT/TSC), Cambridge, Mass.
- FRA Office of Safety Analysis. 2007. Train accident trends. Federal Railroad Administration (FRA) Office of Safety Analysis, Washington, D.C. Available from [http://safetydata.fra.dot.gov/officeofsafety/publicsite/on\\_the\\_fly\\_download.aspx?itemno=7.01](http://safetydata.fra.dot.gov/officeofsafety/publicsite/on_the_fly_download.aspx?itemno=7.01) [cited 31 October 2007].
- Nayak, P.R., and Palmer, D.W. 1980. Issues and dimensions of freight car size: a compendium. Report FRA/ORD-79/56, Federal Railroad Administration (FRA), US Department of Transportation, Washington, D.C.
- Nicolet-Monnier, M., and Gheorghe, A.V. 1996. Quantitative risk assessment of hazardous materials transport systems: rail, road, pipelines and ship. ETHZ, Swiss Federal Institute of Technology, Zurich, Switzerland.
- . OTIF. 2007. Regulations concerning the international carriage of dangerous goods by rail (RID). Intergovernmental Organisation for International Carriage by Rail (OTIF), Berne, Switzerland. Available from [www.mtc.government.bg/upload/docs/RID\\_en01.pdf](http://www.mtc.government.bg/upload/docs/RID_en01.pdf) [cited 28 June 2008].
- Saccomanno, F.F., and El-Hage, S. 1989. Minimizing derailments of railway cars carrying dangerous commodities through effective marshalling strategies. *Transportation Research Record* **1245**: 34–51.
- Saccomanno, F.F., and El-Hage, S. 1991. Establishing derailment profiles by position for corridor shipments of dangerous goods. *Canadian Journal of Civil Engineering*, **18**(1): 67–75. doi:10.1139/191-009.
- Thompson, R.E., Zamejc, E.R., and Ahlbeck, D.R. 1989. Hazardous materials car placement in a train consist. Final Report, Technical Task 6, Contract DTFR53–86-C-00006, Federal Railway Administration (FRA), Washington, D.C.
- Transport Canada. 2007a. TDG newsletter. Transport Canada, Ottawa, Ont. Available from [www.tc.gc.ca/tdg/newsletter/spring2007.pdf](http://www.tc.gc.ca/tdg/newsletter/spring2007.pdf) [cited 31 October 2007].
- Transport Canada. 2007b. Transportation of dangerous goods regulations, Part 10.6 “Location of placarded railway vehicles in a train”. Transport Canada, Ottawa, Ont. Available from [www.tc.gc.ca/tdg/clear/part10.htm#sec 106](http://www.tc.gc.ca/tdg/clear/part10.htm#sec%20106) [cited 31 October 2007].
- TSB. 2004. Statistical summary of railway occurrences. Transportation Safety Board of Canada (TSB), Gatineau, Que. Available from [www.tsb.gc.ca/en/stats/rail/2004/statsummaryrail04.pdf](http://www.tsb.gc.ca/en/stats/rail/2004/statsummaryrail04.pdf) [cited 31 October 2007].
- TSB. 2007. Canadian railway occurrence data system (RODS): 1983–2006. Transportation Safety Board of Canada (TSB), Gatineau, Que.
- USDOT. 2007. Transportation of hazardous material by rail in the US. US DOT 49 CFR 174.85, US Department of Transportation (US DOT), Washington, D.C. Available from [www.a257.g.akamaitech.net/7/257/2422/12feb20041500/edocket.access.gpo.gov/cfr\\_2004/octqtr/pdf/49cfr174.85.pdf](http://www.a257.g.akamaitech.net/7/257/2422/12feb20041500/edocket.access.gpo.gov/cfr_2004/octqtr/pdf/49cfr174.85.pdf) [cited 31 October 2007].